

Objectives

After reading this chapter, you will understand that:

- Hair is class evidence.
- Hair can be used to back up circumstantial evidence.
- Hair absorbs and adsorbs substances both from within the body and from the external environment.

You will be able to:

- Successfully use a compound microscope.
- Describe the structure of a hair.
- Tell the difference between human and animal hair.
- Tell which characteristics of hair are important for forensic analysis.
- Assess the probative value of hair samples.
- Identify questions and ideas that guide scientific investigations.
- Communicate and defend a scientific argument.

“For three days after death, hair and fingernails continue to grow, but phone calls taper off.”

—Johnny Carson, comedian and television host

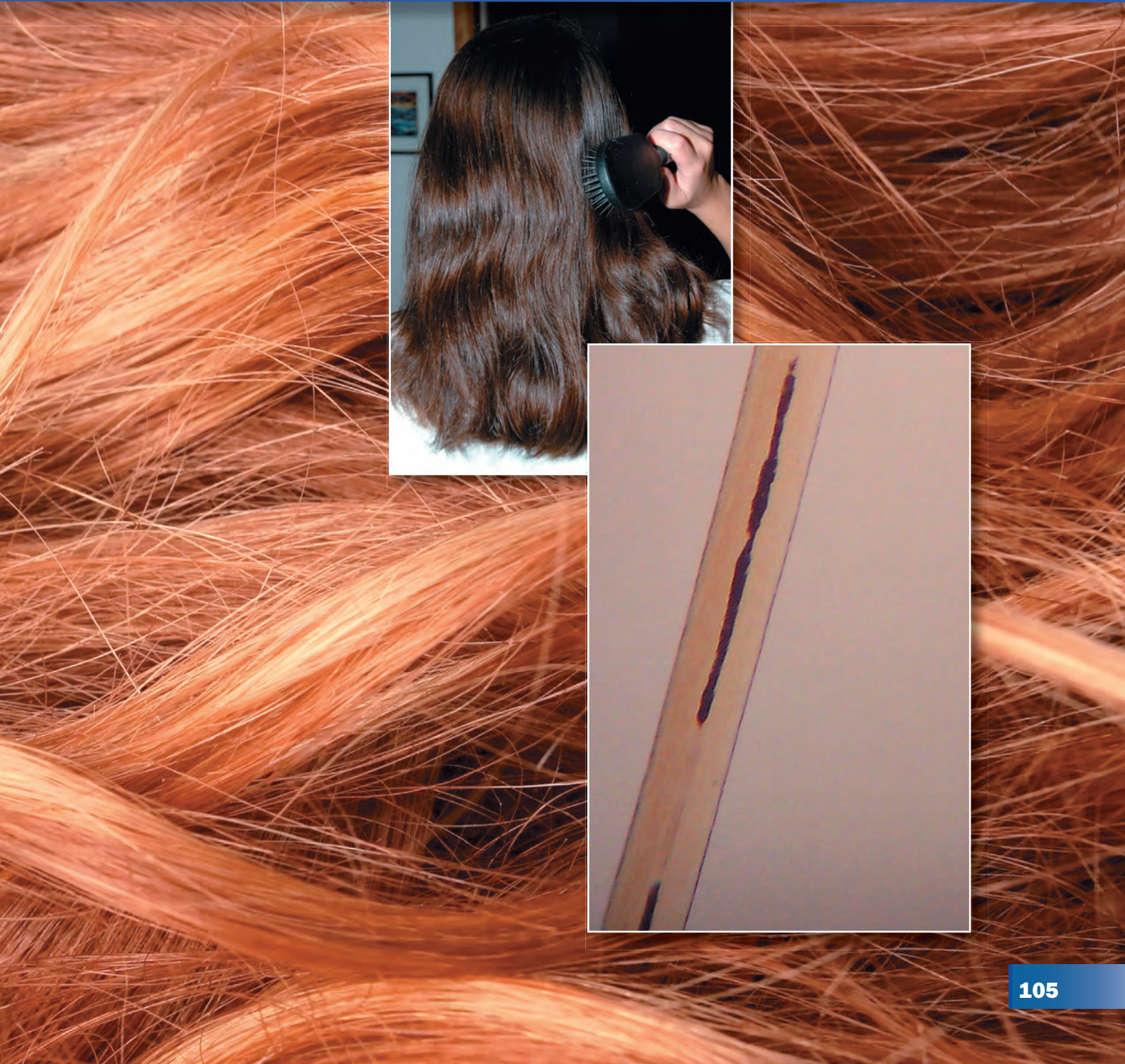

Teacher Note

The TRCD for this chapter includes a PowerPoint presentation, which is an overview of the chapter. It can be used as introductory material or at the end as a review.

The TRCD also contains a crossword puzzle that can be used after students have learned the vocabulary from the end of this chapter.

Neither hair nor fingernails continue to grow after death, contrary to Johnny Carson's joke. The scalp shrinks and, with time, often slips off the skull in one piece, forming what is known as a hair mask. The skin merely shrinks on the fingers so the nails appear longer. See Chapter 13 for the details of death.

Teacher Note

In this chapter, students will observe human and animal hair with a compound microscope. Have students bring in several hairs from a pet for observation and identification before the first activity. The assessment will include solving a crime with only hairs as evidence.



The victim, Lily, with one of her beloved cats.

Hair as Evidence

Investigators often find hair at the crime scene (remember the **Locard Exchange Principle**, introduced in Chapter 1). Hair is considered class evidence and is useful in backing up other circumstantial evidence, such as by placing someone at the crime scene.

Locard Exchange Principle: there is always a cross transfer of evidence between suspect and victim or locale

The Crime Scene

The victim in this case is Lily, the wife of a handsome industrialist who flirted (and maybe more) with five women, all of whom were madly in love with him (or maybe with his money). Each was sure that if he were not married, she would be “the one” for him.

Lily went out riding one spring day, but her horse returned to the stables without her. Her body was found at the edge of a field. The autopsy revealed that her neck had been broken by a powerful blow with a blunt object. Evidence found in an examination of the crime scene suggested a struggle. Investigators sent Lily's clothing to the crime lab. They were especially interested in a wool sweater that yielded many hairs:

- a. horse, brown
- b. human, blond
- c. human, brown
- d. cat, gray
- e. cat, orange

Lily was a brunette with long hair, recently cut. She had two cats. She owned hundreds of expensive shoes and many fur coats and flaunted her diamond jewelry.

Suspects in the case include Lily's husband's five girlfriends:

- Violet is a computer programmer who works for the census bureau. She has long, blond



Violet is a suspect. She is a computer programmer who rents a stall in Lily's stable.



Iris works for Lily's husband and is another suspect.

hair. She enjoys sports, especially horseback riding. She rents a stall in Lily's stable.

- Daisy is a redhead who dyes her hair. It was recently cut short. She is a nurse, a bit overweight, and shares an apartment with Violet. Her cat is a thoroughbred Maine coon cat named Gloxinia. She is a member of the Society for the Prevention of Cruelty to Animals and has recently picketed a local store that sells fur coats. She went to high school with Lily and Camellia.
- Rose is a brunette with long, curly hair. She lives with her golden retriever and keeps pretty much to herself. Rose smokes Merit brand cigarettes. She is one of Lily's neighbors.
- Iris is an outstanding softball player. She plays third base for the Diggers, a team sponsored by a local mortuary. She claims to be a natural blonde, and just got a haircut. She works for Lily's husband.
- Camellia is also a blonde who bleaches her hair, which causes split ends. She runs 10K races throughout the year. She works as a salesperson at the local sporting goods store. It is common knowledge that Iris and Camellia do not like each other.

Procedure Notes

Have the students make up a grid showing suspects and victim versus evidence, then match the known facts. Many are not relevant, but let the students figure that out.

Violet has long, blond hair, cut some time ago, as seen by the long, pointed tip. Daisy is a redhead, but did Daisy dye her hair recently? The approximate 3 cm between root and color change implies that she hadn't dyed her hair for about three months. Daisy lives with a blonde with long hair that could have been transferred to her clothes and then to the victim, but the probability of a secondary transfer, without evidence of a primary one (no red hair on the sweater), is remote. However, in the spring Daisy's cat probably sheds a lot of hair, which gets on everything. What color is the cat? The blond hair on the victim's

Procedure Notes, continued

sweater definitely belonged to the killer because the root shows it was forcibly pulled from the scalp.

Rose could have deposited the brown hair found on the sweater, but it could also be Lily's. The tip suggests it has not been cut for a while—it is more like Lily's. Iris has short, blond hair, very recently cut, as evidenced by the flat-cut end, but when was it cut? Camellia can be ruled out because her hair is frayed, not cut. Or can she? Maybe not all her hair is frayed. However, bleaching can often be seen under the microscope.

The evidence points to Violet. The students may not have the knowledge yet to form an opinion that can withstand cross-examination, but once their ideas are heard, and the facts explained, they will know what observations to make as lab activities progress.

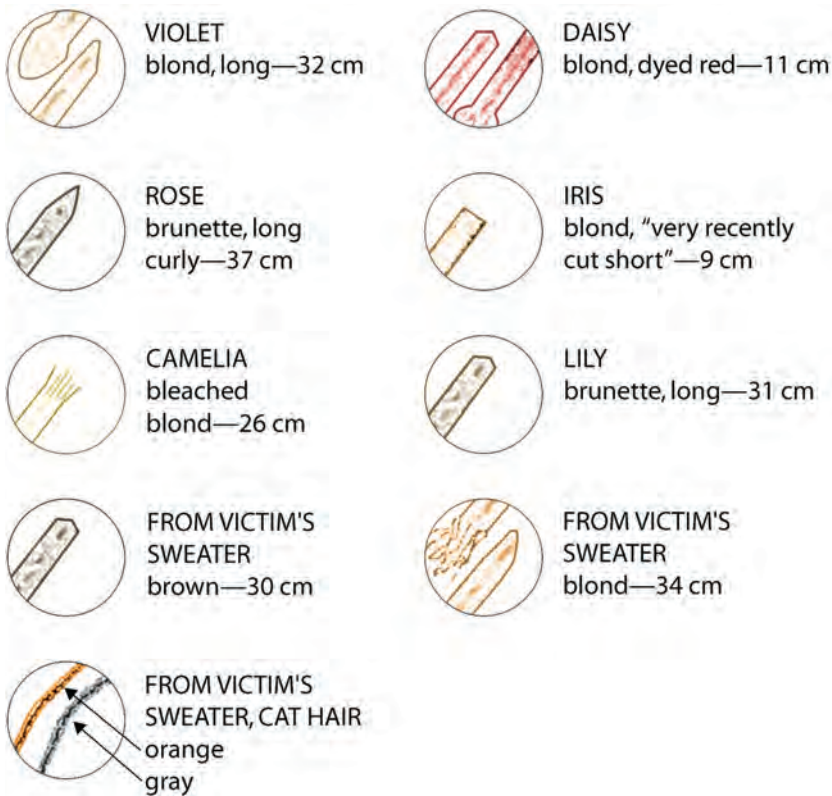

Figure 5.1 Hair from crime scene

Drawings from a microscopic examination of the control and unknown hairs are shown in Figure 5.1.

Is there enough evidence to establish a definite connection to a suspect? If not, what more is needed?

Laboratory Activity 5.1

Observation of Hair

Consider where you have hair on your body. Is the hair all the same?

Materials

- magnifying glass or stereomicroscope
- embedding medium
- compound microscope
- set of animal hairs
- microscope slides
- cover glasses
- glycerin or mineral oil
- scissors
- ruler



SAFETY ALERT! CHEMICALS USED

Always wear goggles and an apron when working in the laboratory

Procedure

1. If you have long enough hair, run a comb or brush through it and collect three to five strands. If you cannot collect hair samples with a comb, then pull three to five strands of hair from your scalp. If your hair is too short, then have a friend cut three to five hairs close to the scalp.
2. Lay your samples out on a piece of white paper. Pull them taut and measure and record their length, in centimeters.
3. Record the hair color.
4. Borrow hair from some lab partners with different-colored hair and look at it under a magnifying glass or microscope. Sometimes playing with the amount of transmitted light will make the hair color more distinctive. Another trick is to place a hair on a black background and observe it in reflected light. Color is a very important characteristic for the forensic scientist. Save your hair samples by taping them in your notebook or placing them in an envelope. You will need them later.
5. You will be using a compound microscope to look at the hairs you have collected so far. Start with the lowest magnification, $40\times$.

Procedure Notes

You can prepare a permanent set of hair samples using an embedding medium such as Norlands NOA65, Paraplast (www1.fishersci.com), or Canadian balsam. The latter two are far more difficult to work with; Paraplast is messy and prone to bubble formation, while balsam must be heated just right, and bubbles may still result. The students will provide some interesting pet hairs. A trip to a pet store or zoo is rewarding. Take a lot of little envelopes and a marking pen. If you have a strong stomach and little pride, go after recognizable roadkill in the spring or fall.

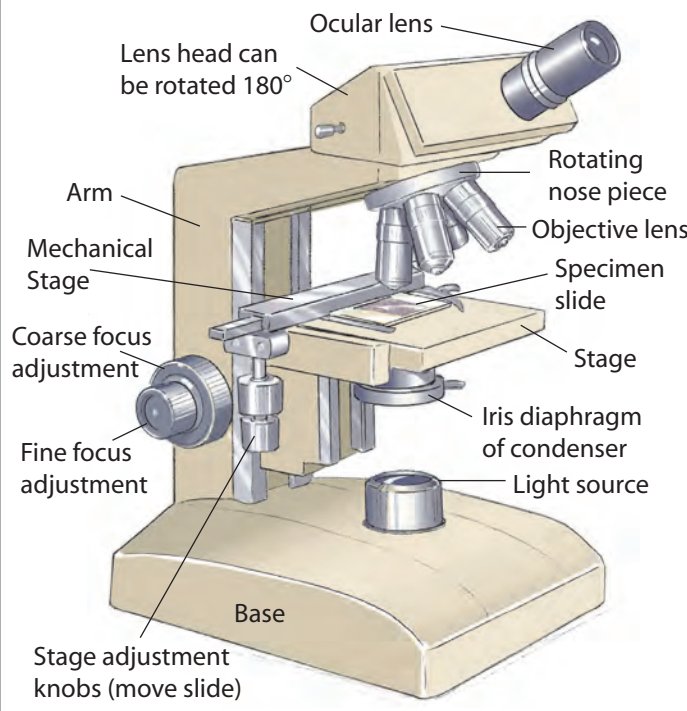

Compound microscope

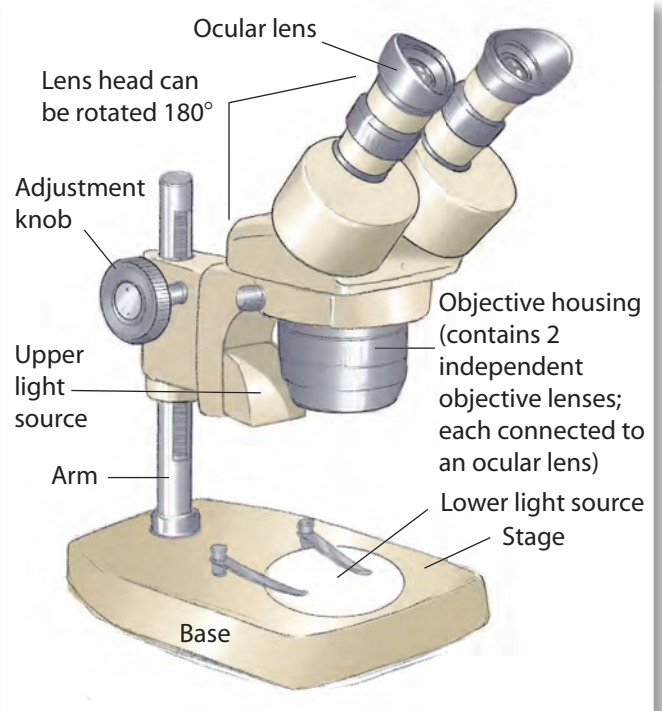

Stereomicroscope

6. Place the hair sample on a microscope slide and add a drop of glycerin or mineral oil. Anchor it with a cover glass. Adjust the light through the

Laboratory Activity 5.1, *continued*

condenser for best viewing. Look at the entire length of your sample. Is it the same throughout? Note the ends. Are they different?

7. Cut a piece of your hair with sharp scissors and compare that end with the others.
8. Repeat your observations with the other strands of your hair.
9. Draw a typical part of your hair and the ends. Make your drawing at least twice as large as what you see.
10. Pluck a hair from your eyebrow or eyelash or arm and compare it to your scalp hair. Examine and draw scalp hairs from at least three other students.
11. Are there any unusual features that set one sample apart from the others?
12. What characteristics do you think a forensic scientist would look for in describing hairs?
13. Record all observations and answer any questions in your lab notebook.

Answers

11. Answers will vary.
12. Color; length; appearance of the tip; any hair treatment; curliness; diameter, perhaps; microscopic structure; smell; etc. See pages 111 and 112.

The Form and Structure of Hair

Most of us can grow only about three feet of hair before it stops getting any longer. The world's longest hair, according to Guinness World Records (www.guinnessworldrecords.com), with a length of more than 18 feet, belonged to Xie Quiping of China.

morphology: form and structure

polymer: a molecule consisting of many identical repeating units; polymers can be naturally occurring or synthetic

cuticle: tough, clear outside covering of the hair shaft

cortex: middle layer of the hair shaft that provides strength; comprises most of the hair mass

medulla: the spongy interior core of hair that gives it flexibility; appears as a canal in the middle of the shaft

You will need to understand the form and structure, or **morphology**, of hair before you can analyze it as evidence. The average human body has about 5 million hairs! Most of these are fine, downlike hairs that cover practically your entire body. Blond people have the most hair on their head—about 120,000 strands. Redheads have at least 80,000. People with black and brown hair have about 100,000. Hairs are continuously shed and renewed at a rate of about 100 each 24-hour period from the scalp alone, so it's not surprising that hair is commonly found in our personal environment (again, remember the Locard Exchange Principle). When two people struggle physically, each is likely to leave his or her hair on the other.

Hair is made up mostly of complex cross-linked protein **polymers**. These polymers are very resistant to breaking down. Hair grows from a tubelike organ in the sublayer of skin (dermis) called a hair follicle (see Figure 5.2). The hair's root is embedded in the follicle. The follicle is linked to the body's blood supply, so whatever is taken into the body is distributed to the part of the hair growing at that time. This can be important in analyzing hair for

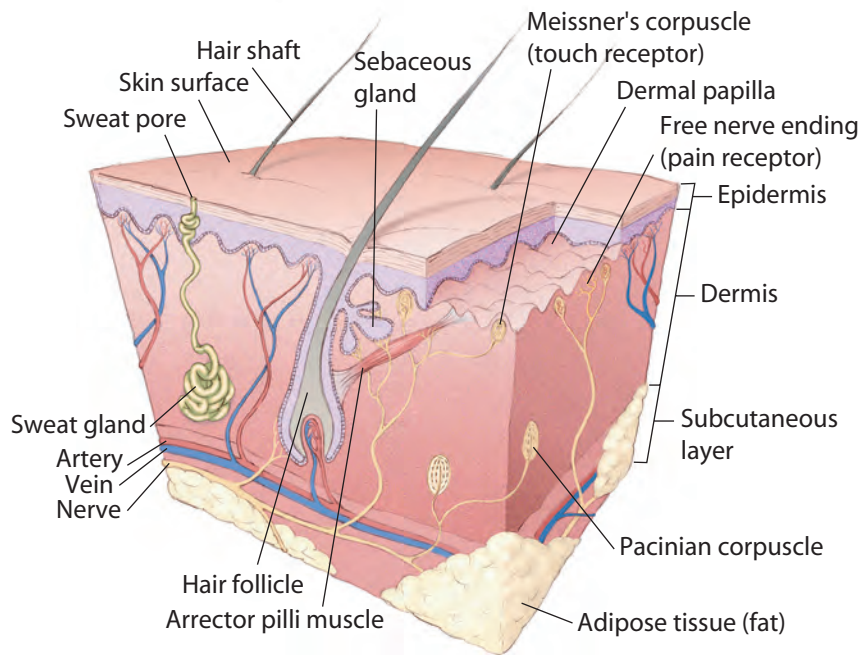

Figure 5.2 Cross section of human skin

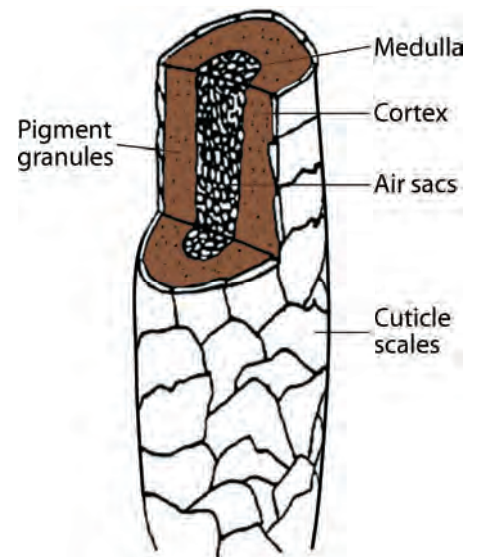

Figure 5.3 Hair shaft

drugs and poisons. The hair shaft extends out through the outermost layer of skin (epidermis) and ends at the tip.

The hair shaft is composed of three parts: the **cuticle**, the **cortex**, and the **medulla** (see Figure 5.3). The cuticle is the clear outside covering of the hair shaft (see Figure 5.4). It is made up of tough, overlapping scales, like those on a fish or like shingles on a roof. Humans have a much finer pattern of scales than animals have, and the scales don't show much variation. Differences in the cuticles of animal hairs can be used to identify species.

The cortex is made up of **keratin** molecules aligned parallel to the length of the shaft (see Figure 5.5).

keratin: a tough protein polymer made up of about 20 different amino acids. The principal one is cystine, which allows strong disulfide bonds to form between protein chains. This cross-linking is what makes hair so resistant to chemical and biological degradation. All that sulfur in keratin also accounts for the distinctive smell of burning hair.

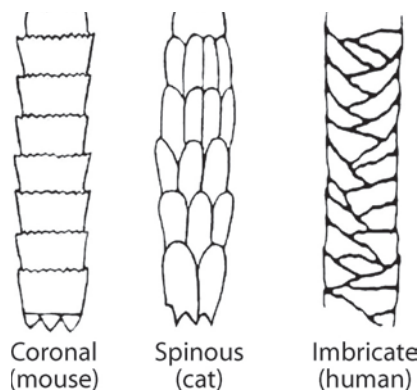
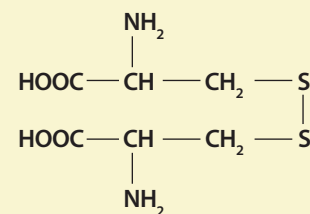

Figure 5.4 Cuticle scale patterns

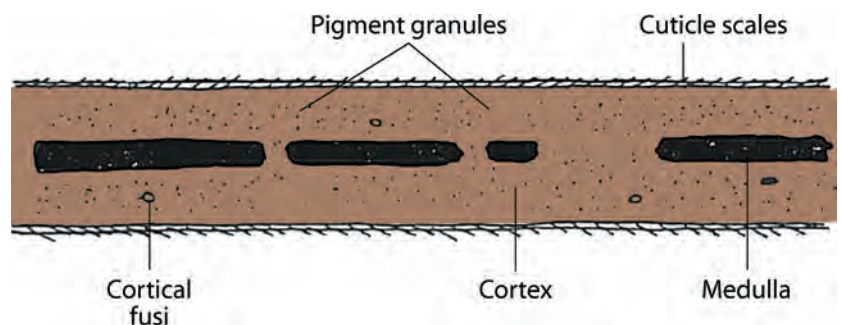

Figure 5.5 Lengthwise cross section of hair shaft

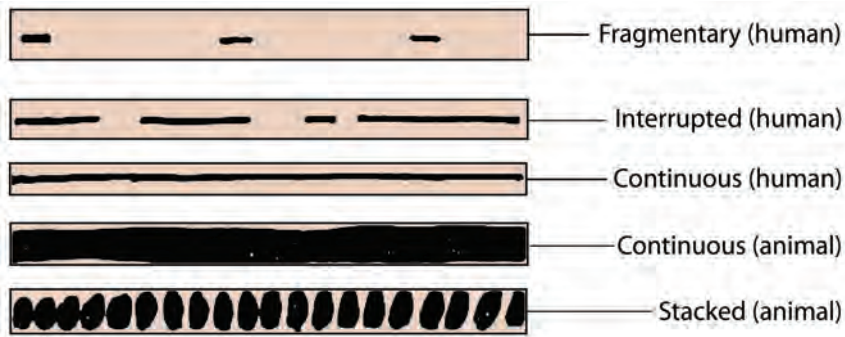

Figure 5.6 Medulla patterns

cortical fusi: irregularly shaped air spaces in the cortex

A scanning electron microscope (SEM) is a type of electron microscope that makes high-resolution, black-and-white, almost three-dimensional images of a sample surface (see photograph below).

	GO TO	www.scilinks.org
	TOPIC	electron microscope
	CODE	forensics2E112

In the cortex is the pigment that makes hair black, brown, yellow, or red. The absence of pigment makes hair gray or white. Little sacs of air called **cortical fusi** are also contained within the cortex; these come in different sizes and shapes, thus providing a possible class characteristic.

These are best seen under the microscope at 100× or higher magnification.

The medulla is a row of cells like a canal running along the center of the cortex (see Figure 5.6). It may appear dark or translucent depending on whether there is air, liquid, or pigment within it, and it can be continuous, interrupted, or in pieces (fragmented). Human hairs generally have no medulla or one that is fragmented, except for the hairs of Native Americans and Asians, where the medulla is usually continuous.

Animal hairs show a wide variety of medullar patterns; investigators can use these patterns to identify some species.

There are also several different possible shapes of hair. Hair can be straight, curly, or kinky, depending on whether the cross section of the shaft is round, oval, or crescent-shaped (see Figure 5.7). It is risky to assign racial characteristics to hair evidence, but generally, hairs found in Asians and Native Americans have a round cross section and no twisting. The hairs of American and European whites, Mexicans, and people of Middle Eastern background show an oval

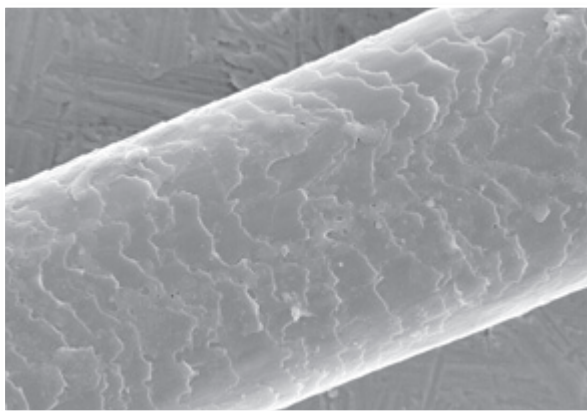

SEM photograph of human hair, ×800

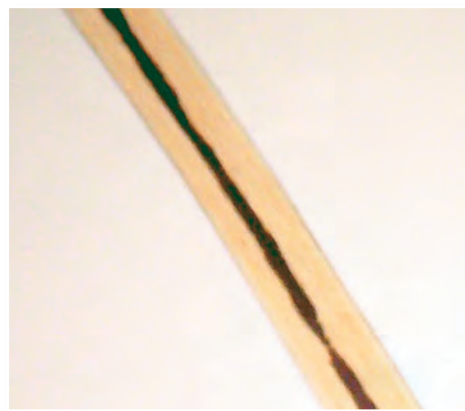

Human hair (blond)

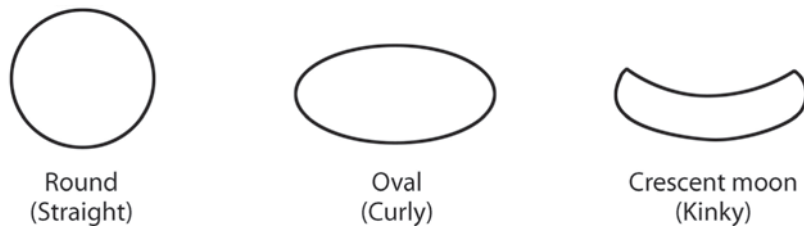

Figure 5.7 Cross sections of human hair

cross section, rarely a twist or **undulation**, and evenly distributed pigmentation. People of African heritage have hair characteristics that include a flat to crescent-shaped cross section with a twist or undulation and dense, clumped pigmentation. Interestingly, hair from a beard is often coarse and triangular in cross section. How would hair with these characteristics look (straight, curly, or kinky)?

Human hair ranges in diameter from 25 to 125 **micrometers** (μm). Coarser hairs grow at a slower rate and fall out less frequently than finer hairs do.

The root can also be important in classifying hair (see Figure 5.8). Head hair grows about 1 cm per month and is replaced about every three to five years with new hair. There are three stages of growth: the **anagen phase**, lasting up to five years (this includes 80 to 90 percent of hair follicles at any one time); the **catagen phase**, which is an intermediate stage; and the **telogen phase** (8 to 10 percent of hair follicles), lasting two to six months, in which the follicle is ready to push out the mature hair. The hairs on your brush or comb are telogen hairs and should reflect that in the bulblike shape of the root, with few, if any, pigment granules near it. Hairs that have been pulled from the scalp in the anagen phase of growth may still have follicular tissue attached and may look stretched, and pigment granules may be seen because the hair was still growing. Animal hair roots can have different shapes but are generally spear-shaped.

A mature human hair should have a bulb-shaped base. The length of the shaft can vary. The tip of a mature hair will taper to a point if it has not been cut or abused for a while. Recently cut hair is squared off at the tip, but within two to three weeks the tip becomes

undulation: in hair morphology, slight waviness

undulated



twisted



micrometer (μm): one-millionth of a meter, or one-thousandth of a millimeter (mm)

anagen phase: period of growth in the hair cycle, averaging three to five years

catagen phase: intermediate period of hair growth, lasting about three weeks

telogen phase: final phase in hair growth, resulting in the loss of hair over about three months

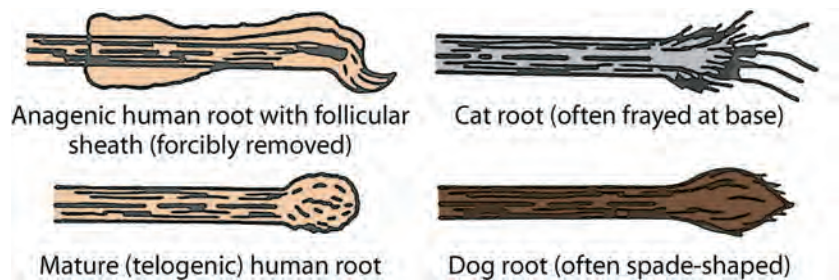

Figure 5.8 Hair roots

rounded. Frayed hair or split ends result from dryness and lack of care (no conditioners), harsh chemicals (bleaches, permanents, or straighteners), and overuse of a blow dryer (too hot); the effects of all of these are made worse by age.



Pencil analogy for a hair

SCILINKS®
NSTA

GO TO www.scilinks.org
TOPIC hair
CODE forensics2E114

A pencil can be a reasonable analogy for a hair. It has a length and a diameter that can be measured. The lead is like a continuous medulla; the surrounding wood, the cortex; the painted exterior, the cuticle. The shape of the pencil (round, hexagonal) is the cross section; the pencil point (rounded, sharp, broken), the tip; and the eraser, the root.

Laboratory Activity 5.2

Microscopic Examination

Procedure Notes

You can use a video or camera attachment to the microscope to project images of hair onto a monitor or screen; this is most helpful in the entire laboratory activity. You can point out features to the whole class, you can view prepared slides from many different animals, and the M.I. can easily be measured directly from the projected image. The scale won't matter, because M.I. is a ratio.

Hair from the mane of a horse is much coarser than the body hair. Porcupine quills are actually dense, fused hair, as is the horn of a rhinoceros.

One of the forensic scientist's most useful tools is the microscope. A piece of evidence such as a hair can reveal important information when examined under the microscope.

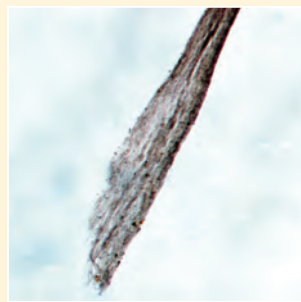

Human hair, frayed end



Human hair, dyed

Materials

- magnifying glass or stereomicroscope
- fine wire with known diameter
- compound microscope
- index card
- samples of hair
- helium-neon laser
- lab tissue
- ruler
- alcohol
- clear nail polish

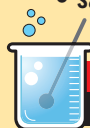

SAFETY ALERT! CHEMICALS USED

Always wear goggles and an apron when working in the laboratory

! SAFETY NOTE Take proper precautions to avoid any possibility of damage to vision. Do not point the laser at anyone's eyes.

Procedure

Do not write in your textbook. Take notes in your science notebook.

Go back to the drawings you did earlier and label the different parts of the hair sample. Is the sample typical of your scalp hair?

1. **Treatment:** Describe the tips of your hair samples (recently cut, cut but rounded, split, narrowing to a point). Observe a hair strand that has been dyed, if one is available. The dye penetrates the cuticle and into the cortex. Bleached hair will appear light, even yellowish. Animal hair sometimes changes color along the hair shaft, such as with a skunk. Draw what you see in your notebook.
2. **Root:** If you didn't get a hair with a root, do so now and examine it. Does it have a bulb? Is it sheathed, as if it had been yanked out? Or is it tapered? Sketch it.
3. **Configuration:** When you stretched your hair in the earlier section of the lab, was it straight, curly, or kinky? It is difficult to prepare a cross section of hair to be analyzed under a microscope. Perhaps you can tell if it is round, oval, or crescent-shaped by twisting a strand back and forth on a microscope slide under low magnification. Comment on the configuration of your hair. Sketch what you see.
4. **Diameter:** The diameter of hair varies along its length, as you probably noticed; but individuals generally can have small variations within the larger range of fine, medium, and coarse. You can estimate the diameter of your hair by laying a piece of wire of known diameter next to it or comparing it to the field of view, if you know that. Some microscopes have a vernier, which is a scale in the eyepiece. Once calibrated, it can be used to accurately measure the diameter of your sample. Measure the diameter of your hair. Does it change along the length of the hair? Compare the diameter of your hair to the diameter of your lab partner's hair. Record your observations.

Optional method for measuring diameter:

A very elegant method of measuring the diameter of a hair is based on **interference patterns** (see Figure 5.9). (You may want to get the help



Human hair (brown)

Procedure Notes

The fine wires that come with a microsyringe are 100 μm in diameter. The shop in your school should have a fine wire or a synthetic bristle from a paintbrush that can be measured with a vernier micrometer.

Answers

Answers will vary.

Microscopic examination of hair from the mummy of Ramses II showed that the pharaoh was a natural redhead and that he used henna to accentuate his hair color. This after 33 centuries!

interference

patterns: patterns that demonstrate the wave nature of light, resulting from constructive (additive) and destructive combinations of light waves. This happens when a small object deflects coherent light so that the wave fronts travel different distances. This phenomenon is called *diffraction*.

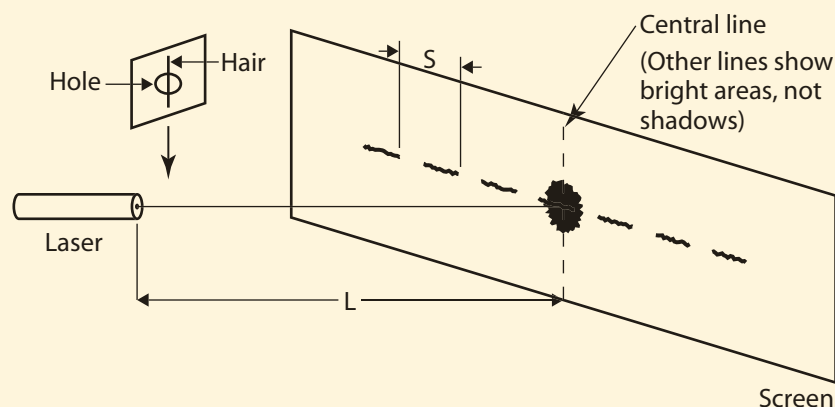

Figure 5.9 Determination of hair diameter

of a physics teacher for this.) You can prepare your own sample for a quick and easy measurement. Cut a 1-inch-square piece of index card and punch a hole in it. Tape a hair or calibrated wire across it. Put the hair across the output of a He-Ne laser and project the image 1 to 2 meters onto a screen. You should be able to see an interference pattern of alternating light and dark images of the hair projected on the screen. Measure the distance between the centers of either the light or the dark bands (S). This procedure is basically the same as the one Thomas Young used in 1802, which clearly demonstrated the wave nature of light. Of course, he didn't have a laser as a light source.

The equation to solve is:

$$d = \frac{lL}{10S}$$

where d = the diameter of the hair in micrometers; l = the wavelength of the light source (for He-Ne, 635 nm); L = the distance from the light source to the screen, in meters; and S = the distance between the central bright line and the one next to it in centimeters. Record the diameter of your hair. Be sure to show all measurements and calculations.

5. **Structure:** The cuticle in human hair is close-packed, transparent, and fine; therefore, it is difficult to see. You can make the structure visible by making a cast of the hair. Clean a strand of your hair by pulling it through a folded tissue moistened with alcohol to remove grease and oil. Now coat a microscope slide with clear nail polish and press your hair into it. After the polish becomes sticky but not dry, remove the hair and examine the cuticle impression at 40 or 100 \times . Draw a picture of it. The cuticles of animal hairs can be quite varied and are generally much



Gray human hair—no pigmentation

coarser than those of humans. Collect three or more different animal hairs for comparison. Compare your drawings to those shown in Figure 5.4.

The cortex contains pigment granules composed of **melanin** or melaninlike molecules, fairly evenly spread out for Caucasians but often densely clumped in African American hair. Using 400× magnification, with your hair samples in glycerin or mineral oil, try to find similarities and differences in the pigment granules and cortical fusi of your hair and several hairs from other people. Be aware that sacs such as the fusi or medulla that contain air will look dark with transmitted light but bright in reflected light.

A principal difference between human and animal hair structure is the medulla. Not only does it look quite different, but it is much thicker relative to the diameter of the hair shaft in animals than in humans. The medullary index (M.I.) is a measure of the relative thickness and is determined by dividing the diameter (thickness) of the medulla by the diameter of the hair and multiplying by 100 (see Figure 5.10). Because the M.I. is a ratio between the two measurements, the units do not matter as long as they are consistent. Animal hair usually has an M.I. of more than 33. Measure or estimate the M.I. of your hair and that of at least three different animal hairs.

Record all observations, measurements, and calculations on the structure of your hair.

melanin: a natural pigment found in the skin. Ultraviolet rays in sunlight make it more concentrated, causing tanning.

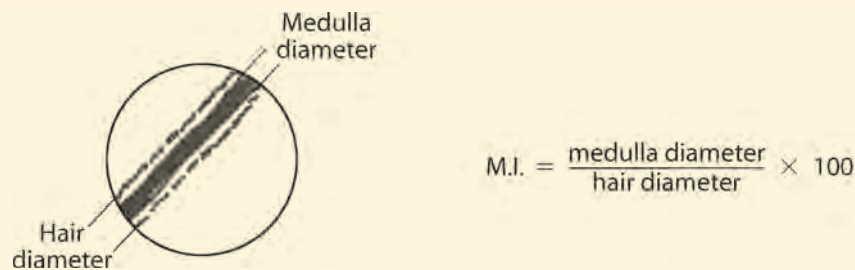
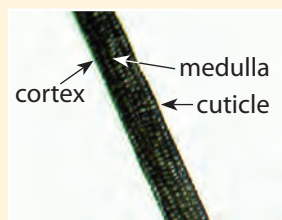

Figure 5.10 Medullary index calculation



Deer hair, M.I. practically 100



Rabbit hair, M.I. = 80

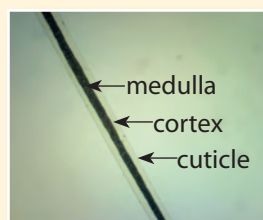

Raccoon hair, M.I. = 35



Polar bear hair

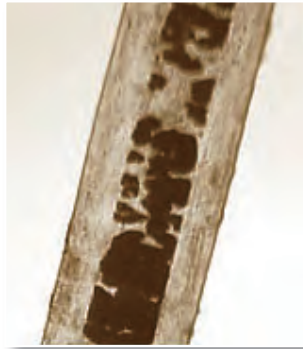

Camel hair



Sheep hair

Back at the Scene of the Crime

Now let's return to the crime scene. Have you changed your mind about who may be the primary suspect(s)? What other observations should you make? What questions should you ask?

Investigators consider hair and fibers they find at the scene of a crime to be trace evidence. This type of physical evidence cannot by itself give positive identification; however, it can support other evidence developed during the course of an investigation. The forensic investigator's job is to compare different pieces of circumstantial evidence to reduce the possible sources to the smallest number they can obtain.

If hairs are collected at the scene of the crime, the investigator would first determine what species they came from. You now know how to differentiate between human and animal hair. If the hair is human, characteristics are compared to narrow the collected evidence to a group that includes the suspect.

As you have learned, each person can have hairs with different characteristics, while there may be many similarities from one person to another. This is why the more hair samples the investigator examines, the better. We cannot say that any two hairs from one person are identical and unique, as we can with fingerprints. Nevertheless, hair can be valuable evidence because it does have a wide range of class characteristics, it is persistent (ever try to remove a hair from a sweater?), it resists degradation, and it is commonly found at crime scenes.

An investigator may associate an unknown hair with an individual by comparing the characteristics you have observed here. The more

association: a link between an unknown sample and known evidence

characteristics that are similar, the greater the degree of probability of **association**. On the other hand, a *single significant difference* between unknown (**questioned**) and known (**exemplar**) hair would strongly suggest

separate sources. For example, the questioned hairs found on the victim's body are all long, black, and round in cross section, with a continuous medulla. The suspect's hair samples are long, black, and round, but with no medulla. This difference means the investigator cannot say there is a direct association.

Careful examination of hair evidence cannot determine the age or sex of the individual (although DNA typing of the hair root can).

There are a number of things we can learn from hair samples:

- whether the source is animal or human
- racial origin (sometimes)
- location on the source's body
- whether the hair has been chemically treated (dyed, permed, straightened)
- color
- whether the hair was forcefully removed (usually)

The outcome of many cases was decided long before the advent of new scientific discoveries and modern forensic technology. In the case study of Colin Ross (page 124), DNA analysis could have provided conclusive evidence of a link between Ross's blanket and the victim.

questioned: term used in forensics to describe a sample of unknown origin; for example, a hair was found on a jacket, but we do not know whose head it came from

exemplar: term used in forensics to describe a sample of known origin; for example, we know that this hair was pulled out of so-and-so's scalp

5.1: Product Tampering

From the files of coauthor John Funkhouser

A lawyer had a young woman with long, blond hair come to her complaining about a hair-care product that caused hair loss. The lawyer referred her to me for analysis of the product. She came to my office with an envelope with hair samples. She showed me a completely bald area, about the size of a tennis ball, on the top of her head where her hair had fallen out. She blamed her hair loss on the use of a well-known hair conditioner which she brought in for analysis.

It seemed strange to me that only one area of her scalp had been affected. Sudden loss of hair can be caused by contact with strong alkalis (substances with a high pH, like lye and oven cleaners, that dissolve proteins). I suspected one of these substances was involved, especially after learning that her boyfriend had taken a few courses of college chemistry. In addition, I had noticed that the product the woman brought me had no odor. Commercial hair removers (depilatories), on the other hand, are not so alkaline, and generally smell bad. Therefore, I figured I should first look at pH.

CASE STUDY

I purchased the same product (I even found the same lot number) and slit both tubes open lengthwise, the “known” that I had purchased and the “unknown” that the young woman had submitted for analysis. I used pH paper to measure the degree of alkalinity along the slit. The control, or known sample, showed a pH of 6, as did the bottom of the sample the woman had submitted for testing. However, the pH of the unknown sample increased toward the opening of the tube until it tested at a pH of 13–14, serious enough to cause hair loss. It was obvious that someone had “doctored” the product by introducing an alkaline solution through the opening of the tube. This was a clear case of product tampering!

**CASE STUDY
CONTINUED**



Change in pH from bottom to top of “unknown” hair conditioner tube

Case 5.1 is a small case but it illustrates a lot of what a forensic scientist may deal with, as well as some deductive reasoning based upon experience. Note the use of a “known” from the store—in this case, the control—and the “unknown” sample from the suspect. The lawyer the young woman had contacted was informed of the outcome and dropped her like a hot potato. There was no conclusive proof of who had actually tampered with the product, and the matter was dropped. Hopefully, someone learned that the misuse of chemicals can be easily discovered with chemistry basics.

Hair as a Chemical Indicator

Hair can collect materials that come into the body and are delivered by the blood to the hair root, where they are deposited in the cortex. As analytical testing methods have become more sensitive and efficient, many drugs and their **metabolites**, vitamins, and poisons can now be detected in just a few millimeters of hair.

metabolite: a specific product of a substance, formed by chemical processes in the body

Suggested Assignment

See page 228 in Chapter 8, Additional Projects, which includes Napoleon. Also, refer your students to *ChemMatters* (1998), 16(4), pp. 4–6, and *New Scientist* (Oct. 14, 1982), pp. 101–104, for research in the Napoleon case.

Drug analysis of hair backs up standard blood and urine tests because drugs are typically gone from blood just a few hours after the last use. Analysis can generally detect drug metabolites in urine for a period of three to five days from last use. Hair, as you know, grows about 1 centimeter a month, so drug use can be traced over longer periods of time. By analyzing bits of hair, continuous or infrequent use can be discovered and even matched to an approximate timeline, such as every week, or three months ago (3 cm from the root). Think of drug testing of blood, then, as a snapshot of use; of urine tests as a time exposure; and of hair testing as a true album of use.

Scientists have had some success in using hair's metal content to diagnose dietary deficiencies and diseases. In forensics, chronic heavy metal poisoning (such as by arsenic, lead, or mercury) can be easily discovered. An interesting case of historical forensic investigation involved looking for arsenic in locks of Napoleon's hair.

false positive: a test result that comes out positive when it should not; often caused by contamination or failure to run a control

A hair's cuticle is typically coated with scalp oils, so investigators can sometimes find traces of a person's environment. They have detected smoke from crack cocaine this way, as well as heavy metal industrial pollutants, such as cadmium. Because of this, someone who has not smoked crack or been deliberately poisoned may show a **false positive** in a hair analysis, just by having been exposed to incidental chemicals in the environment. Investigators should always take measures and perform tests to rule out false positives. Someone could be wrongly convicted on the basis of misleading test results. How would you try to avoid a false positive in such a case?

The small amount of DNA in the root of the hair can now be isolated and amplified; bits of DNA can be analyzed to provide more information that can be useful in identification. Mitochondrial DNA can be obtained from the hair's shaft. (See Chapter 11, "DNA Analysis.")

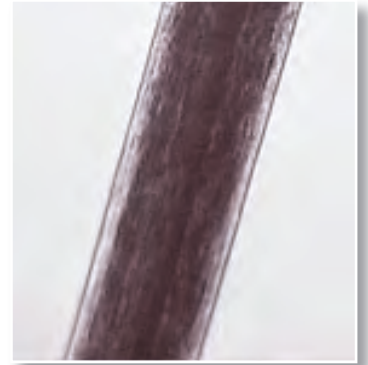

Gorilla hair

5.2: Colin Ross

A young girl, Alma Tirtsche, was found strangled and bludgeoned to death in Melbourne, Australia, in 1922. Her naked body had been wrapped in a blanket and dumped in an alley. There was no blood found at the scene, prompting investigators to conclude that she had been killed in one place and then transported to the alley at a later time.

As the investigation progressed, Colin Ross became a suspect. Police searched his home and obtained two more blankets that they sent to Dr. Charles Taylor for analysis. On one he found strands of reddish-gold hair, the same color as Alma's. Dr. Taylor determined that the hairs were indeed human and that they were most likely female (they were more than 12 inches long). He also concluded that because the hair had so much pigmentation, it must be from a young person. Some of the hairs had roots, suggesting that they were pulled out during a violent encounter. The hair evidence indicating that Alma had been in contact with the blanket found at Ross's home was enough to convict him.

Colin Ross was found guilty of murder and hanged four months later.

More than eighty years later, in his book *Gun Alley: Murder, Falsehood, and Failure of Justice*, Kevin Morgan proved that Ross was most probably innocent. Largely because of Morgan's research, Colin Ross was exonerated and officially pardoned May 27, 2008.

CASE STUDY



Colin Ross

Answers

1. Before this activity, collect hair samples from three people: one from the suspect (known), one from the purse (questioned), and one from the victim. The one on the purse should be forcibly removed. Then you can set up the outcome any way you want. The questioned hair can match the known hair, and you have identified the perpetrator. Or, if it doesn't match, you hope the students will ask for the victim's hair to compare to the known hair. Other evidence to look for might include blood or skin on the purse.

Students should be encouraged to make a table using the following characteristics: type (animal or human), color, body location (maybe), tip condition, length, shaft diameter, configuration (kinky, straight, curly), root, pigment density and distribution (maybe), medulla, cuticle scale pattern, cortical fusi abundance (maybe), and cosmetic treatment. Students can use the table on Blackline Master 5.1, found on the TRCD, as a template. A lab report or letter to the prosecutor could accompany it.

2. The body is constantly losing hair, more so in violent situations. Hair is persistent; it catches on and clings to clothing, rugs, dust balls, and the like. Hair is resistant to chemical and biological degradation. It absorbs chemicals ingested by the source.
3. class evidence because each person's hairs may have many different characteristics, and there may be similarities between individuals
4. structural characteristics
5. The polar bear hair has an M.I. of 30. Usually animal hair has an M.I. greater than 33, so this could be construed as human; it can be differentiated by the cuticle.
6. 100
7. The medulla is found on the interior of the hair; it may be continuous, fragmented, or absent.

Checkpoint Questions

Answer the following questions. Keep the answers in your notebook, to be turned in to your teacher at the end of the unit.

1. A woman was attacked one evening on her way home from work. She swung her purse at the attacker, hitting him hard in the head. He fled. Later she was able to identify him from a police lineup. Police examined the purse and found some hair. The following samples were submitted to the crime lab for analysis:

Known: suspect's hair

Unknown: hair from purse

Compare the unknown (questioned) hair with the known (exemplar) hair. In your opinion, is there sufficient evidence to convict the suspect of assault? Why or why not? What more could be done?

2. What characteristics make hair a useful forensic tool?
3. Is hair considered class or individual evidence? Why?
4. What is meant by the "morphology" of hair?
5. What is the M.I. of the polar bear hair shown on page 118? Could such hair be confused with human hair? If so, how could it definitely be differentiated from human?
6. How many hairs fall out during an average day?
7. Where is the medulla found, and what might it look like?

- 8. Where is the cuticle found, and what might it look like?**
- 9. Where in the hair are pigment granules found?**
- 10. If the cross section of a hair is found to be oval in shape, would you expect the hair to be straight, curly, or kinky?**
- 11. What is meant by the anagen phase, and how long does it last?**
- 12. At any given time, approximately how many hairs are found to be in the anagen phase?**
- 13. What is the telogen phase, and how long does it typically last?**
- 14. What are a few advantages of using hair for drug testing over blood and urine tests?**
- 15. Name a disadvantage of using hair for drug testing.**
- 16. How would you decide approximately how long ago a hair sample was dyed?**
- 17. If you were asked whether a particular hair sample were human or animal, what would you look for? Explain, using words and diagrams.**

Answers, *continued*

- 8.** The cuticle is found on the outside of the hair shaft; it has a scale pattern.
- 9.** in the cortex
- 10.** curly
- 11.** The anagen phase is the active growth stage that lasts up to five years.
- 12.** 80–90 percent
- 13.** The follicle gets the hair ready to fall out; this phase lasts from two to six months
- 14.** Hair is very durable. It will last a long time, and it can give a history or timeline of drug use or poisoning.
- 15.** Hair may pick up environmental pollutants, giving false positives, or a person may cut his or her hair, removing the evidence.
- 16.** Measure the distance from the line where the dye begins to the root and divide by the growth rate of 1 cm per month.
- 17.** The investigator would primarily study the medullary index; he or she would also examine the cuticle, thickness, and color banding.

Answers, *continued*

18. The investigator would look at the length, color, tip condition, diameter, configuration, cross section, medulla type, and any cosmetic treatment.
19. Fibers that are also hair include wool, mohair, cashmere, and, more rarely, llama, alpaca, and camel.
20. comparing DNA from the root of the hair found on Ross's blanket to that of the victim

Answers

1. Answers will vary.
2. Tip should change from flat to rounded. Dull scissors can cause fraying.
3. Tape hair on a board and expose it directly to sunlight (not through a window). Cover a portion with paper or plastic; this will be the control. You can repeat exposure through window glass, in a hot area, or under an infrared bulb. What happens in a microwave?
4. Answers will vary with the degree of searching. Students should review both sides and offer an opinion.
5. Answers will vary with the degree of searching.
6. Answers will vary with the degree of searching.
7. Answers will vary.

18. If you were asked to compare an unknown (questioned) sample to a known sample of human hair to match or identify origin, what would you look for? Would your observations give conclusive evidence? Explain, using words and drawings.

19. What fibers can also be considered hair?

20. Had the Colin Ross case occurred within the last decade or so, what test(s) could have been performed to determine guilt or innocence?

Additional Projects

1. Treat hair samples with a variety of dyes and note changes in morphology. You will be able to compare them more easily by dipping only part of the hair strands into the dye. Also try Grecian Formula, depilatories, and other products that are used on hair. Are there distinctive characteristics to use as class evidence? As individual evidence?
2. Note daily changes in the tips of your hair from when they are freshly cut to three or four weeks later.
3. Invent a test to measure the effects of weathering (specifically, ultraviolet radiation) on hair. What makes hair eventually decompose?
4. Investigate the legal aspects of taking a hair sample from a suspect, as you did in identifying issues around fingerprinting. Is taking a suspect's hair a violation of the Fifth Amendment?
5. Research the effect of hair treatment (including dyeing, bleaching, washing, and the like) on the detection of drugs and poisons.
6. Review articles written about the use of hair analysis for medical diagnosis or in environmental chemistry.
7. Investigate the Colin Ross case and his alleged innocence. What do you think?

References

Books and Articles

- Evans, C. *The Casebook of Forensic Detection*. New York: John Wiley, 1996. See also his newest edition of the same title, New York: Berkley Trade, 2007.
- Fisher, D. Chapter 4 in *Hard Evidence*. New York: Dell, 1995.
- Genge, N. E. *The Forensic Casebook: The Science of Crime Scene Investigation*. New York: Ballantine, 2002.
- The Hairy Book: The Uncut Truth about the Weirdness of Hair*. Reading, MA: Planet Dexter, 1997.
- Kurland, M. Chapter 9 in *How to Solve a Murder*. New York: MacMillan, 1995.
- Ragle, Larry. *Crime Scene*. New York: Avon Books, 2002.
- Siegel, Jay A. *Forensic Science: The Basics*. Boca Raton, FL: CRC Press, 2007.
- Schiltz, G. *Forensic Laboratory Science and Detective Mystery Writing*. Batavia, IL: Flinn Scientific, 2000.

Films and Videos

- Beaten by a Hair: Ultraviolet Microscopy*, #CBA 8606. Films for the Humanities & Science, P.O. Box 2053, Princeton, NJ 08543-2053; www.films.com (1999).

Websites

- www.fbi.gov/hq/lab/fsc/backissu/july2000/deedric1.htm; excellent and thorough FBI manual on hair evidence
- www.fbi.gov/hq/lab/fsc/backissu/jan2004/research/2004_01_research01b.htm; Microscopy of Hair, Part 1: A Practical Guide and Manual for Human Hairs
- www.fbi.gov/hq/lab/fsc/backissu/july2004/research/2004_03_research02.htm; Microscopy of Hair, Part II: A Practical Guide and Manual for Animal Hairs
- www.crimelibrary.com/criminal_mind/forensics/trace/1.html; a killer caught by a hair
- www.hair-science.com; L'Oréal's site with all sorts of information on hair; everything about hair from science to care
- www.keratin.com/; everything you ever wanted to know about the biology of hair and then some